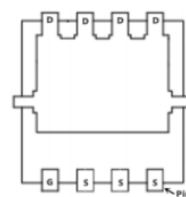
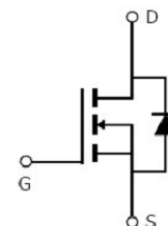

Main Product Characteristics

V_{DSS}	40V
$R_{DS(on)}$	1.4m Ω (typ.)
I_D	120A ①

DFN 5*6-8L

Pin Assignment

Schematic Diagram

Features and Benefits

- Advanced Process Technology
- Special designed for PWM, load switching and general purpose applications
- Ultra low on-resistance with low gate charge
- Fast switching and reverse body recovery
- 150°C operating temperature



Description

It utilizes the latest processing techniques to achieve the high cell density and reduces the on-resistance with high repetitive avalanche rating. These features combine to make this design an extremely efficient and reliable device for use in power switching application and a wide variety of other applications.

Absolute max Rating

Symbol	Parameter	Max.	Units
I_D @ TC = 25°C	Continuous Drain Current, V_{GS} @ 10V ①	120	A
I_D @ TC = 100°C	Continuous Drain Current, V_{GS} @ 10V ①	82	
I_{DM}	Pulsed Drain Current ②	400	
P_D @TC = 25°C	Power Dissipation ③	125	W
V_{DS}	Drain-Source Voltage	40	V
V_{GS}	Gate-to-Source Voltage	± 20	V
E_{AS}	Single Pulse Avalanche Energy @ L=0.5mH	400	mJ
I_{AS}	Avalanche Current @L=0.5mH	40	A
T_J T_{STG}	Operating Junction and Storage Temperature Range	-55 to +150	°C

Thermal Resistance

Symbol	Characterizes	Typ.	Max.	Units
$R_{\theta JC}$	Junction-to-case ③	—	1	$^{\circ}C/W$
$R_{\theta JA}$	Junction-to-ambient ($t \leq 10s$) ④	—	50	$^{\circ}C/W$

Electrical Characterizes @ $T_A=25^{\circ}C$ unless otherwise specified

Symbol	Parameter	Min.	Typ.	Max.	Units	Conditions
$V_{(BR)DSS}$	Drain-to-Source breakdown voltage	40	—	—	V	$V_{GS} = 0V, I_D = 250\mu A$
$R_{DS(on)}$	Static Drain-to-Source on-resistance	—	1.4	1.8	m Ω	$V_{GS}=10V, I_D=20A$
		—	2	2.6		$V_{GS}=4.5V, I_D=20A$
$V_{GS(th)}$	Gate threshold voltage	1	—	2.2	V	$V_{DS} = V_{GS}, I_D = 250\mu A$
I_{DSS}	Drain-to-Source leakage current	—	—	1	μA	$V_{DS} = 32V, V_{GS} = 0V$
I_{GSS}	Gate-to-Source forward leakage	—	—	100	nA	$V_{GS} = 20V$
		—	—	-100		$V_{GS} = -20V$
Q_g	Total gate charge (4.5V)	—	42	—	nC	$I_D = 20A,$ $V_{DS}=15V,$ $V_{GS} = 10V$
Q_{gs}	Gate-to-Source charge	—	10	—		
Q_{gd}	Gate-to-Drain("Miller") charge	—	15	—		
$t_{d(on)}$	Turn-on delay time	—	18	—	nS	$V_{GS}=10V, V_{DD} = 15V,$ $R_{GEN}=3.3\Omega$ $I_D = 20A$
t_r	Rise time	—	8	—		
$t_{d(off)}$	Turn-Off delay time	—	58	—		
t_f	Fall time	—	30	—		
C_{iss}	Input capacitance	—	3950	—	pF	$V_{GS} = 0V$ $V_{DS} = 20V$ $f = 1MHz$
C_{oss}	Output capacitance	—	1110	—		
C_{riss}	Reverse transfer capacitance	—	80	—		

Source-Drain Ratings and Characteristics

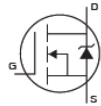
Symbol	Parameter	Min.	Typ.	Max.	Units	Conditions
I_S	Continuous Source Current (Body Diode) ①	—	—	100	A	MOSFET symbol showing the integral reverse p-n junction diode. 
V_{SD}	Diode Forward Voltage	—	—	1.2	V	$I_S=1A, V_{GS}=0V, T_J = 25^{\circ}C$

Test circuits and Waveforms

EAS Test Circuit:



Gate charge test circuit:



Switching Time Test Circuit:



Switching Waveforms:



Notes:

- ① Calculated continuous current based on maximum allowable junction temperature.
- ② Repetitive rating; pulse width limited by max. junction temperature.
- ③ The power dissipation PD is based on max. junction temperature, using junction-to-case thermal resistance.
- ④ The value of $R_{\theta JA}$ is measured with the device mounted on 1 in 2 FR-4 board with 2oz. Copper, in a still air environment with $T_A = 25^\circ\text{C}$

Typical electrical and thermal characteristics

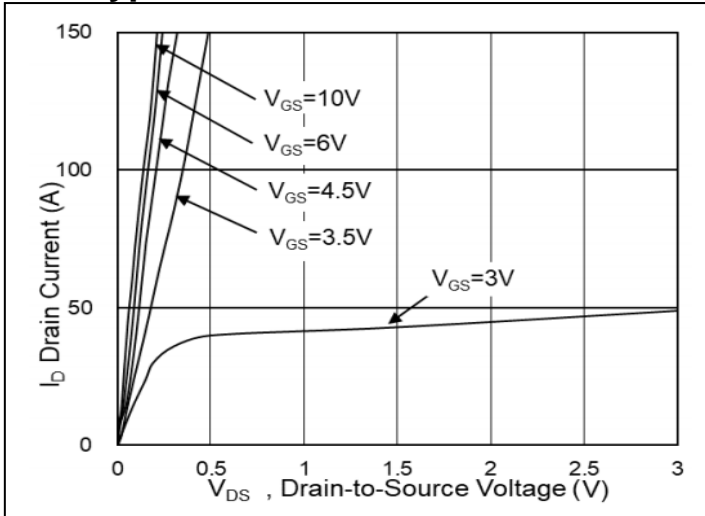

Figure 1: Typical Output Characteristics

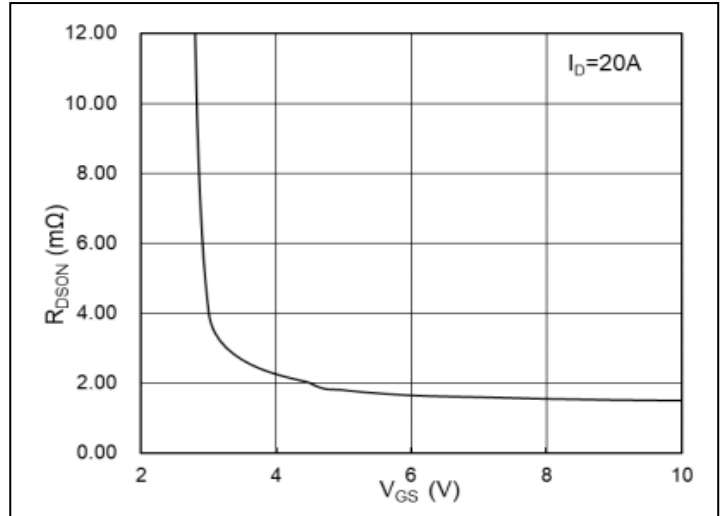

Figure 2: On-Resistance vs. G-S Voltage

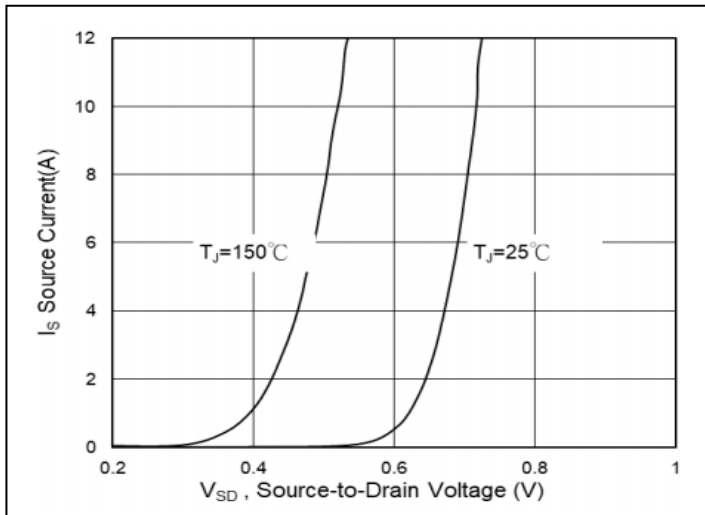

Figure 3: Source Drain Forward Characteristics

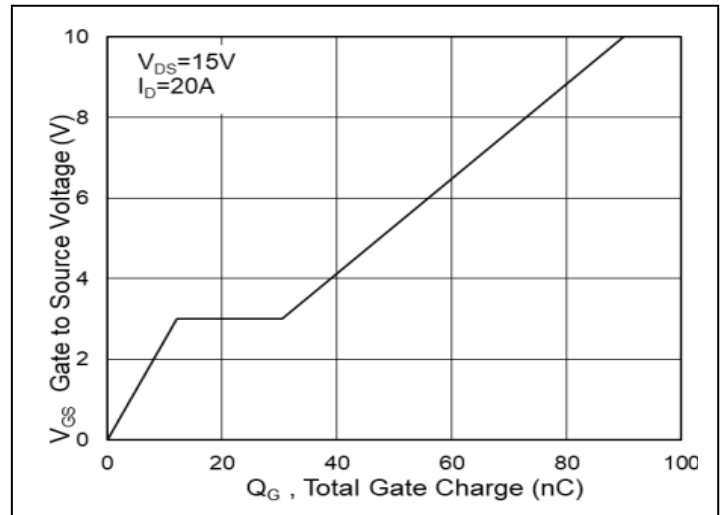

Figure 4: Gate Charge Characteristics

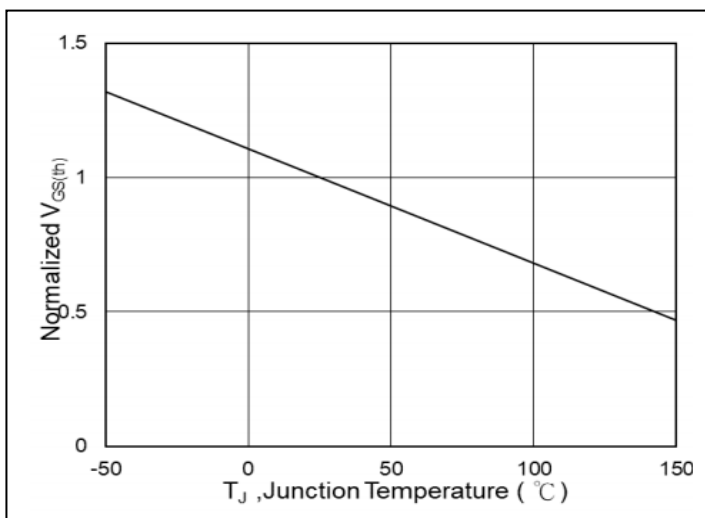

Figure 5: Normalized $V_{GS(th)}$ vs. Junction Temperature

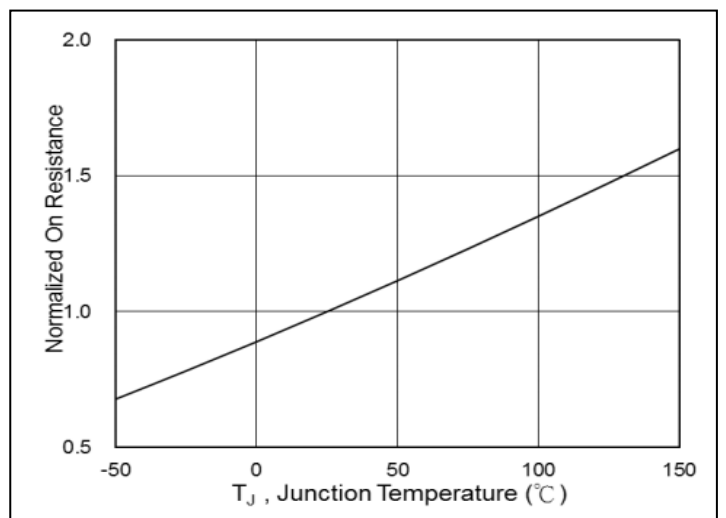

Figure 6: Normalized On-Resistance vs. Junction Temperature

Typical electrical and thermal characteristics

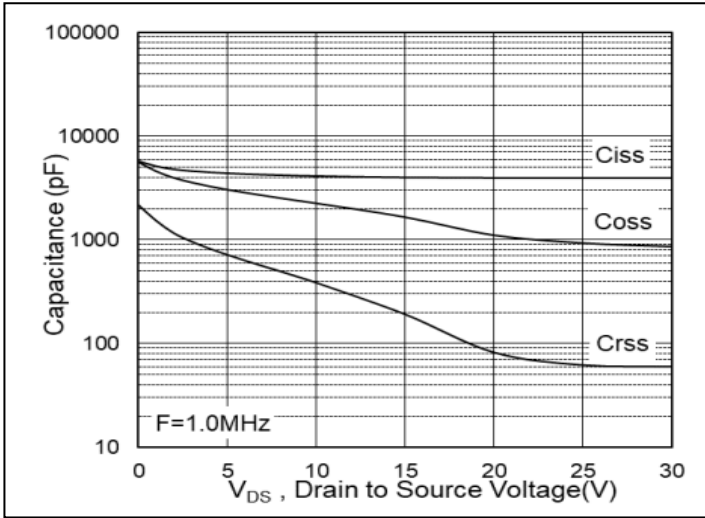

Figure 7: Capacitance

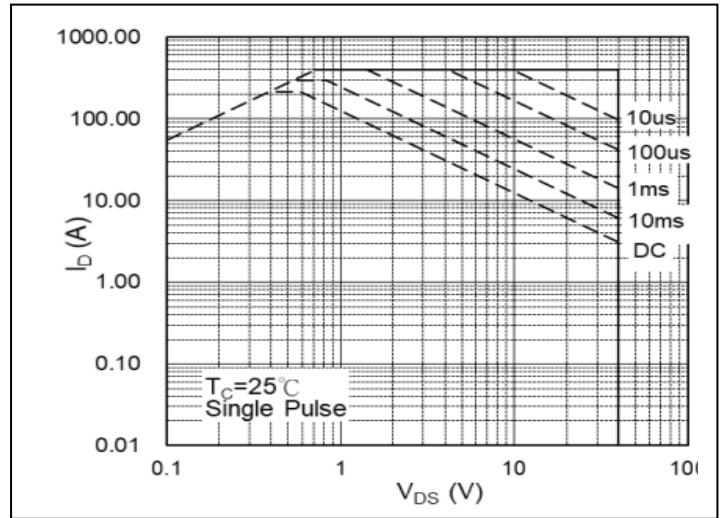

Figure 8: Safe Operation Area

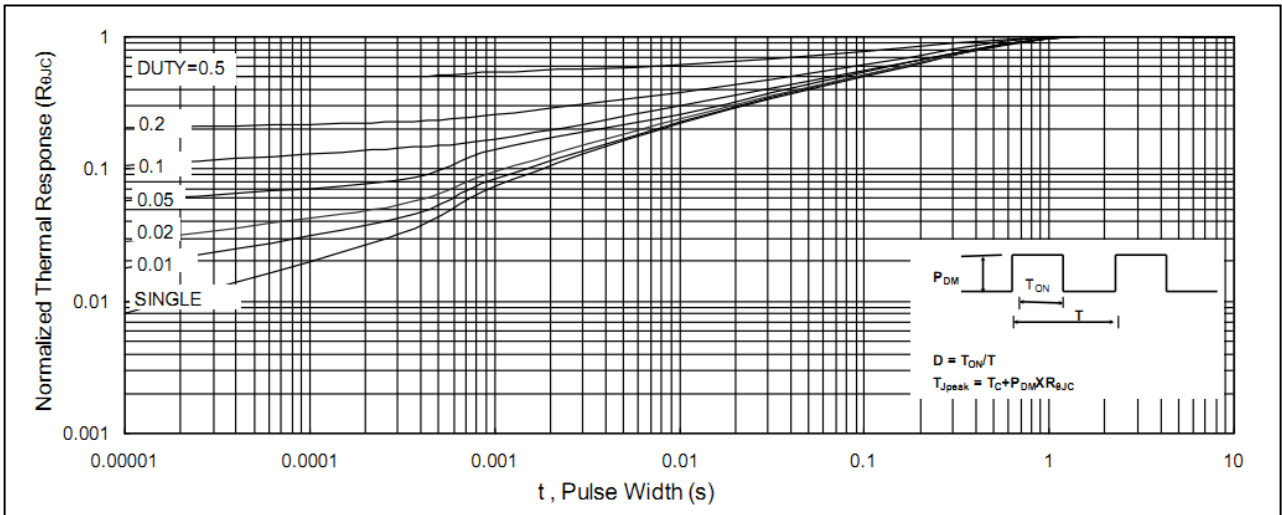
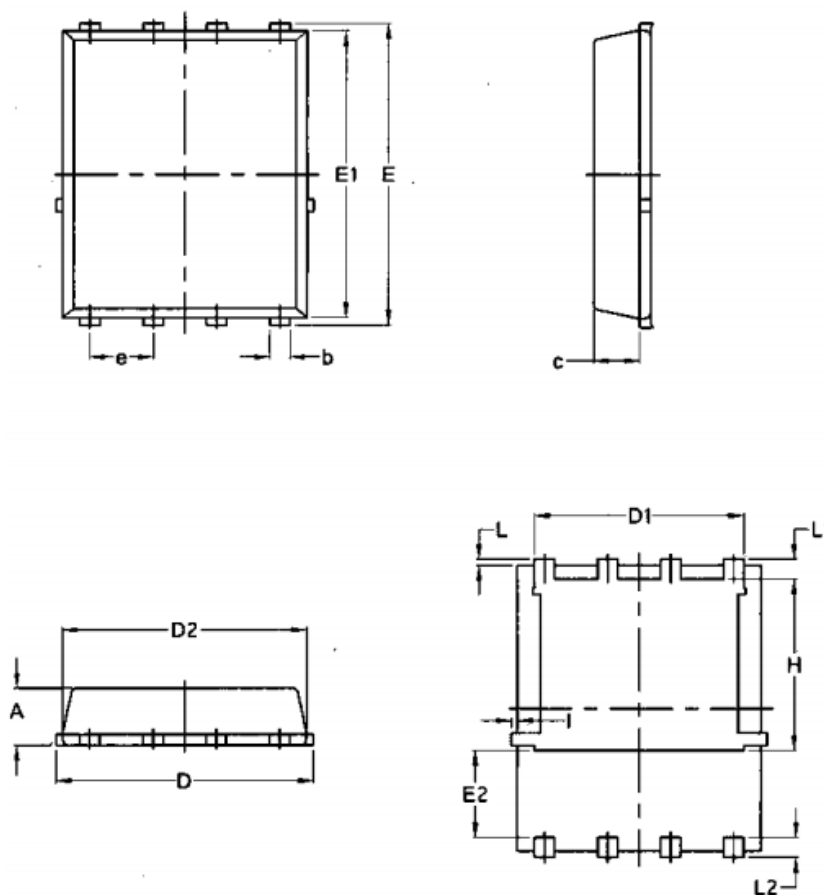

Figure 9: Transient Thermal Impedance

Mechanical Data:



Symbol	Common			
	mm		Inch	
	Mim	Max	Min	Max
A	1.03	1.17	0.0406	0.0461
b	0.34	0.48	0.0134	0.0189
c	0.824	0.0970	0.0324	0.082
D	4.80	5.40	0.1890	0.2126
D1	4.11	4.31	0.1618	0.1697
D2	4.80	5.00	0.1890	0.1969
E	5.95	6.15	0.2343	0.2421
E1	5.65	5.85	0.2224	0.2303
E2	1.60	/	0.0630	/
e	1.27 BSC		0.05 BSC	
L	0.05	0.25	0.0020	0.0098
L1	0.38	0.50	0.0150	0.0197
L2	0.38	0.50	0.0150	0.0197
H	3.30	3.50	0.1299	0.1378
I	/	0.18	/	0.0070

ATTENTION:

- Any and all Silikron products described or contained herein do not have specifications that can handle applications that require extremely high levels of reliability, such as life-support systems, aircraft's control systems, or other applications whose failure can be reasonably expected to result in serious physical and/or material damage. Consult with your Silikron representative nearest you before using any Silikron products described or contained herein in such applications.
- Silikron assumes no responsibility for equipment failures that result from using products at values that exceed, even momentarily, rated values (such as maximum ratings, operating condition ranges, or other parameters) listed in products specifications of any and all Silikron products described or contained herein.
- Specifications of any and all Silikron products described or contained herein stipulate the performance, characteristics, and functions of the described products in the independent state, and are not guarantees of the performance, characteristics, and functions of the described products as mounted in the customer's products or equipment. To verify symptoms and states that cannot be evaluated in an independent device, the customer should always evaluate and test devices mounted in the customer's products or equipment.
- Silikron Semiconductor CO.,LTD. strives to supply high-quality high-reliability products. However, any and all semiconductor products fail with some probability. It is possible that these probabilistic failures could give rise to accidents or events that could endanger human lives, that could give rise to smoke or fire, or that could cause damage to other property. When designing equipment, adopt safety measures so that these kinds of accidents or events cannot occur. Such measures include but are not limited to protective circuits and error prevention circuits for safe design, redundant design, and structural design.
- In the event that any or all Silikron products(including technical data, services) described or contained herein are controlled under any of applicable local export control laws and regulations, such products must not be exported without obtaining the export license from the authorities concerned in accordance with the above law.
- No part of this publication may be reproduced or transmitted in any form or by any means, electronic or mechanical, including photocopying and recording, or any information storage or retrieval system, or otherwise, without the prior written permission of Silikron Semiconductor CO.,LTD.
- Information (including circuit diagrams and circuit parameters) herein is for example only ; it is not guaranteed for volume production. Silikron believes information herein is accurate and reliable, but no guarantees are made or implied regarding its use or any infringements of intellectual property rights or other rights of third parties.
- Any and all information described or contained herein are subject to change without notice due to product/technology improvement, etc. When designing equipment, refer to the "Delivery Specification" for the Silikron product that you intend to use.

Customer Service**Worldwide Sales and Service:**

Sales@silikron.com

Technical Support:

Technical@silikron.com

Suzhou Silikron Semiconductor Corp.

501 , NW-20,Nanopolis, 99th Jinjihu Avenue ,Industrial Park ,Suzhou ,P.R, CHINA

TEL: (86-512) 62560688

FAX: (86-512) 62560688-8092

E-mail: Sales@silikron.com