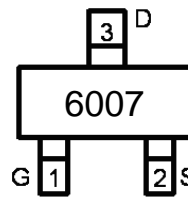
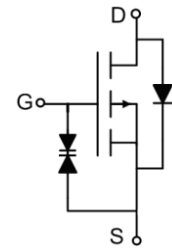

**Main Product Characteristics:**

$V_{DSS}$	-50V
$R_{DS(on)}$	2.1ohm(typ.)
$I_D$	-130mA

**SOT-23**

**Marking and pin Assignment**

**Schematic diagram**
**Features and Benefits:**

- Advanced MOSFET process technology
- Special designed for Line current interrupter in telephone sets, Relay, high speed and line transformer drivers and general purpose applications
- Ultra low on-resistance with low gate charge
- Fast switching and reverse body recovery

**Description:**

It utilizes the latest processing techniques to achieve the high cell density and reduces the on-resistance. These features combine to make this design an extremely efficient and reliable device for use in line current interrupter in telephone sets and a wide variety of other applications

**Absolute max Rating:**

Symbol	Parameter	Max.	Units
$I_D$ @ TC = 25°C	Continuous Drain Current, $V_{GS}$ @ -10V①	-130	mA
$I_D$ @ TC = 100°C	Continuous Drain Current, $V_{GS}$ @ -10V①	-100	
$I_{DM}$	Pulsed Drain Current②	-520	
$P_D$ @TC = 25°C	Power Dissipation③	230	mW
$V_{DS}$	Drain-Source Voltage	-50	V
$V_{GS}$	Gate-to-Source Voltage	± 20	V
ESD	ESD Rating (HBM module)	1	KV
$T_J$ $T_{STG}$	Operating Junction and Storage Temperature Range	-55 to + 150	°C

**Thermal Resistance**

Symbol	Characterizes	Typ.	Max.	Units
$R_{\theta JA}$	Junction-to-ambient ( $t \leq 10s$ ) ④	—	556	°C/W
	Junction-to-Ambient (PCB mounted, steady-state) ④	—	540	°C/W

**Electrical Characterizes** @ $T_A=25^{\circ}\text{C}$  unless otherwise specified

Symbol	Parameter	Min.	Typ.	Max.	Units	Conditions
$V_{(BR)DSS}$	Drain-to-Source breakdown voltage	-50	—	—	V	$V_{GS} = 0V, I_D = -10\mu A$
$R_{DS(on)}$	Static Drain-to-Source on-resistance	—	2.1	7	$\Omega$	$V_{GS}=-10V, I_D = -130mA$
$V_{GS(th)}$	Gate threshold voltage	-0.8	—	-2	V	$V_{DS} = V_{GS}, I_D = -1mA$
$I_{DSS}$	Drain-to-Source leakage current	—	—	-0.1	$\mu A$	$V_{DS}=-40V, V_{GS} = 0V$
		—	—	-1		$V_{DS}=-50V, V_{GS} = 0V$
		—	—	-50		$T_J = 125^{\circ}\text{C}$
$I_{GSS}$	Gate-to-Source forward leakage	—	—	10	$\mu A$	$V_{GS} = 20V$
		—	—	-10		$V_{GS} = -20V$
$g_{fs}$	Forward Transconductance	50	—	—	S	$V_{DS} = -25V, I_D = -130mA$
$C_{iss}$	Input Capacitance	—	45	—	pF	$V_{GS} = 0;$ $V_{DS} = -5V;$ $f = 1\text{ MHz}$
$C_{oss}$	Output Capacitance	—	18	—		
$C_{rss}$	Reverse Transfer Capacitance	—	11	—		
$t_{d(on)}$	Turn-On Delay Time	—	3.1	—	ns	$V_{DD} = -15V;$ $I_D = -2.5A;$ $R_L = 50\text{ohm}$
$t_r$	Rise Time	—	1.3	—		
$t_{d(off)}$	Turn-Off Delay Time	—	18	—		
$t_f$	Fall Time	—	7.5	—		

**Source-Drain Ratings and Characteristics**

Symbol	Parameter	Min.	Typ.	Max.	Units	Conditions
$I_S$	Continuous Source Current (Body Diode)	—	—	130	mA	MOSFET symbol showing the integral reverse p-n junction diode. 
$I_{SM}$	Pulsed Source Current (Body Diode)	—	—	520	mA	
$V_{SD}$	Diode Forward Voltage	—	—	-1.3	V	

**Notes:**

- ① Calculated continuous current based on maximum allowable junction temperature.
- ② Repetitive rating; pulse width limited by max. junction temperature.
- ③ The power dissipation PD is based on max. junction temperature, using junction-to-case thermal resistance.
- ④ The value of  $R_{\theta JA}$  is measured with the device mounted on 1 in 2 FR-4 board with 2oz. Copper, in a still air environment with  $T_A = 25^{\circ}\text{C}$

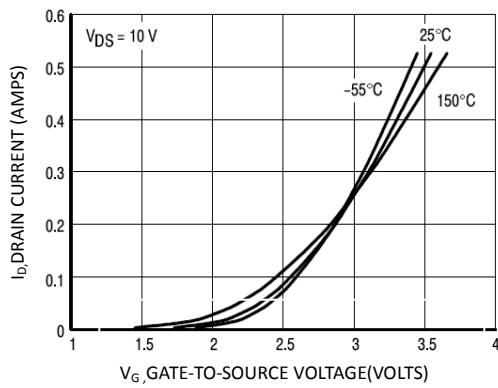

Fig 1: Transfer Characteristics

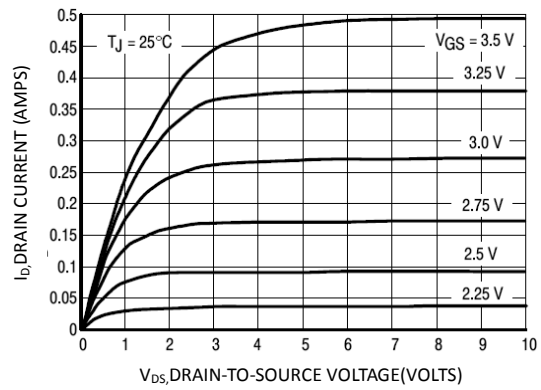

Fig 2: Output Curve

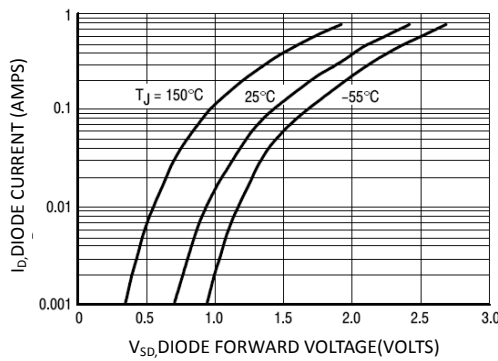

Fig 3: Body Diode Forward Curve

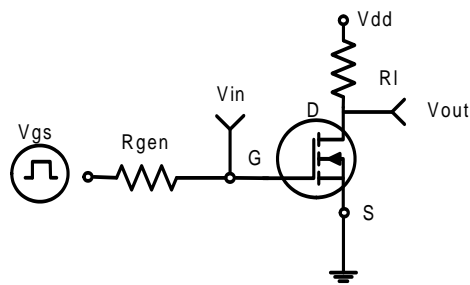

Fig 4: Switching Test Circuit

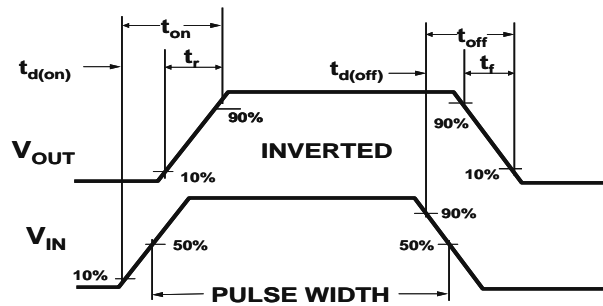
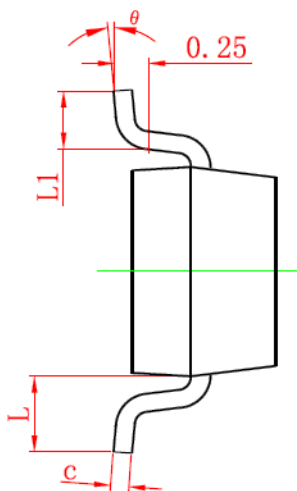
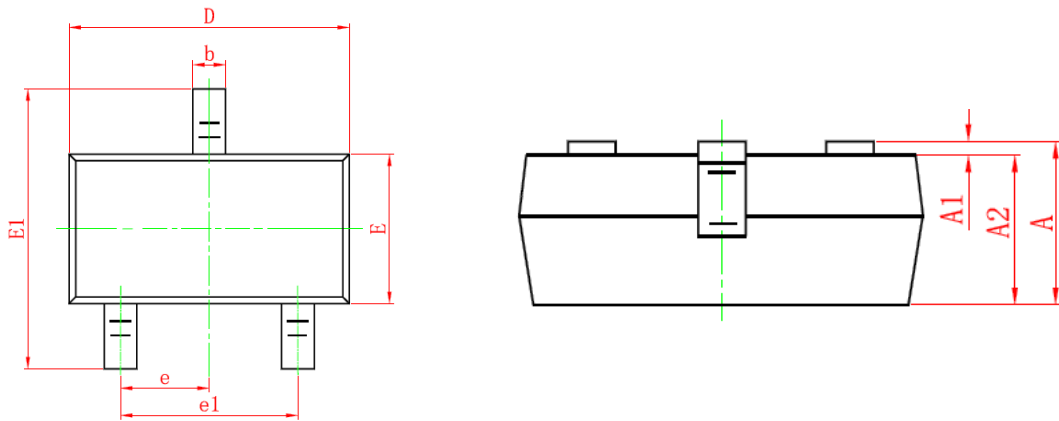

Fig 5: Switching Waveforms

## SOT-23 PACKAGE INFORMATION

Dimensions in Millimeters (UNIT:mm)



Symbol	Dimensions in Millimeters	
	MIN.	MAX.
<b>A</b>	<b>0.900</b>	<b>1.150</b>
<b>A1</b>	<b>0.000</b>	<b>0.100</b>
<b>A2</b>	<b>0.900</b>	<b>1.050</b>
<b>b</b>	<b>0.300</b>	<b>0.500</b>
<b>c</b>	<b>0.080</b>	<b>0.150</b>
<b>D</b>	<b>2.800</b>	<b>3.000</b>
<b>E</b>	<b>1.200</b>	<b>1.400</b>
<b>E1</b>	<b>2.250</b>	<b>2.550</b>
<b>e</b>	<b>0.950TYP</b>	
<b>e1</b>	<b>1.800</b>	<b>2.000</b>
<b>L</b>	<b>0.550REF</b>	
<b>L1</b>	<b>0.300</b>	<b>0.500</b>
<b>θ</b>	<b>0°</b>	<b>8°</b>

### NOTES

- All dimensions are in millimeters.
- Tolerance  $\pm 0.10\text{mm}$  (4 mil) unless otherwise specified
- Package body sizes exclude mold flash and gate burrs. Mold flash at the non-lead sides should be less than 5 mils.
- Dimension L is measured in gauge plane.
- Controlling dimension is millimeter, converted inch dimensions are not necessarily exact.

**Ordering and Marking Information**
**Device Marking: 6007**

**Package (Available)**  
**SOT-23**  
**Operating Temperature Range**  
**C : -55 to 150 °C**

**Devices per Unit**

Package Type	Units/ Tube	Tubes/ Inner Box	Units/ Inner Box	Inner Boxes/ Carton Box	Units/ Carton Box
SOT23	3000pcs	10pcs	30000pcs	4pcs	120000pcs

**Reliability Test Program**

Test Item	Conditions	Duration	Sample Size
High Temperature Reverse Bias(HTRB)	$T_j = 150^\circ\text{C}$ @ 80% of Max $V_{DSS}/V_{CES}/VR$	168 hours 500 hours 1000 hours	3 lots x 77 devices
High Temperature Gate Bias(HTGB)	$T_j = 150^\circ\text{C}$ @ 100% of Max $V_{GSS}$	168 hours 500 hours 1000 hours	3 lots x 77 devices

**ATTENTION:**

- Any and all Silikron products described or contained herein do not have specifications that can handle applications that require extremely high levels of reliability, such as life-support systems, aircraft's control systems, or other applications whose failure can be reasonably expected to result in serious physical and/or material damage. Consult with your Silikron representative nearest you before using any Silikron products described or contained herein in such applications.
- Silikron assumes no responsibility for equipment failures that result from using products at values that exceed, even momentarily, rated values (such as maximum ratings, operating condition ranges, or other parameters) listed in products specifications of any and all Silikron products described or contained herein.
- Specifications of any and all Silikron products described or contained herein stipulate the performance, characteristics, and functions of the described products in the independent state, and are not guarantees of the performance, characteristics, and functions of the described products as mounted in the customer's products or equipment. To verify symptoms and states that cannot be evaluated in an independent device, the customer should always evaluate and test devices mounted in the customer's products or equipment.
- Silikron Semiconductor CO.,LTD. strives to supply high-quality high-reliability products. However, any and all semiconductor products fail with some probability. It is possible that these probabilistic failures could give rise to accidents or events that could endanger human lives, that could give rise to smoke or fire, or that could cause damage to other property. When designing equipment, adopt safety measures so that these kinds of accidents or events cannot occur. Such measures include but are not limited to protective circuits and error prevention circuits for safe design, redundant design, and structural design.
- In the event that any or all Silikron products(including technical data, services) described or contained herein are controlled under any of applicable local export control laws and regulations, such products must not be exported without obtaining the export license from the authorities concerned in accordance with the above law.
- No part of this publication may be reproduced or transmitted in any form or by any means, electronic or mechanical, including photocopying and recording, or any information storage or retrieval system, or otherwise, without the prior written permission of Silikron Semiconductor CO.,LTD.
- Information (including circuit diagrams and circuit parameters) herein is for example only ; it is not guaranteed for volume production. Silikron believes information herein is accurate and reliable, but no guarantees are made or implied regarding its use or any infringements of intellectual property rights or other rights of third parties.
- Any and all information described or contained herein are subject to change without notice due to product/technology improvement, etc. When designing equipment, refer to the "Delivery Specification" for the Silikron product that you intend to use.

**Customer Service****Worldwide Sales and Service:**

Sales@silikron.com

**Technical Support:**

Technical@silikron.com

**Suzhou Silikron Semiconductor Corp.**

Building 11A Suchun Industrial Square, 428# Xinglong Street, Suzhou P.R. China

**TEL:** (86-512) 62560688

**FAX:** (86-512) 65160705

**E-mail:** Sales@silikron.com